



PAR20

Dimmable Recessed Light

50W halogen equivalent

Features

- Innovative anti-glare lens technology
- Energy Star certified (3000K)
- Available in a variety of CCTs and beam angles
- Special high CRI models
- Top performing light output and efficacy
- High Power Factor
- Compatible with most ANSI/NEMA approved dimmers designed for LED use
- UL certified
- Comprehensive five-year warranty
- Tested per IESNA LM-79-2008



Contact

Head Office
400 March Road
Ottawa ON Canada
K2K 3H4
(613) 270-7879

North America (toll free):
1-800-396-9109

sales@leapfroglighting.com
www.leapfroglighting.com

Leapfrog Lighting's ENERGY STAR certified PAR20 LED lamp provides industry-leading light quality, output power, and efficacy as a result of our patented intelligent optics lens and high-efficiency, high-reliability LED source and driver electronics.

LIGHT QUALITY

Evenly distributed, glare-free light with gentle roll-off at edges

APPLICATIONS

Indoor and unexposed outdoor down-lighting applications

LIFE EXPECTANCY

40,000 hours
ENERGY STAR rated models: 25,000 hours based on preliminary testing

PERFORMANCE

Dimmable, high efficacy (lm/W), single light source

COLOR

Ultra-consistent color temperature control critical to multi-lamp applications, with high CRI and pleasing CCT options.

WATTAGE EQUIVALENCY

50 Watt halogen equivalent

SPECIFICATIONS

CCT ¹	CRI ²	BEAM	LM	W	LM/W	PART
2700K	82	24°	598	8	75	1001-P20LC-2704
	82	38°	598	8	75	1001-P20LC-2702
	82	60°	598	8	75	1001-P20LC-2703
3000K	95	24°	496	8	62	1001-P20LC-2707
	95	38°	496	8	62	1001-P20LC-2705
	95	60°	496	8	62	1001-P20LC-2706
5000K	82	24°	605	8	77	1001-P20LC-3004
	82	38°	605	8	77	1001-P20LC-3002
	82	60°	605	8	77	1001-P20LC-3003
	95	24°	518	8	65	1001-P20LC-3007
	95	38°	518	8	65	1001-P20LC-3005
	95	60°	518	8	65	1001-P20LC-3006
5000K	82	24°	668	8	84	1001-P20LC-5003
	82	38°	668	8	84	1001-P20LC-5001
	82	60°	668	8	84	1001-P20LC-5002

1. Tolerances as per ANSI C78.377-2008 Nominal CCT categories
 2. CRI refers to the "General CRI" described as Ra in CIE 13.3
 3. Lifetime as defined by IESNA LM-80
 4. Compatible with ANSI C78.21-2011 dimensional requirements
 5. Duv values and tolerances as per ANSI C78.377-2008 Nominal CCT, Table 1, page 8

GENERAL

Min. lifetime ³	40,000 hours
Base type	E26/E27
Weight	5.6 oz.
Dimensions ⁴	PAR20L

ELECTRICAL

Voltage, nominal	120 VAC
Power factor	> 0.94
Dimming range	Flicker free down to 10% light output

OPTICAL

Duv ⁵	< ±0.006
------------------	----------

BASE TYPE

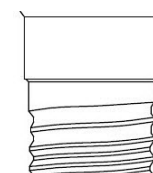

E26/27

POLAR INTENSITY DIAGRAMS

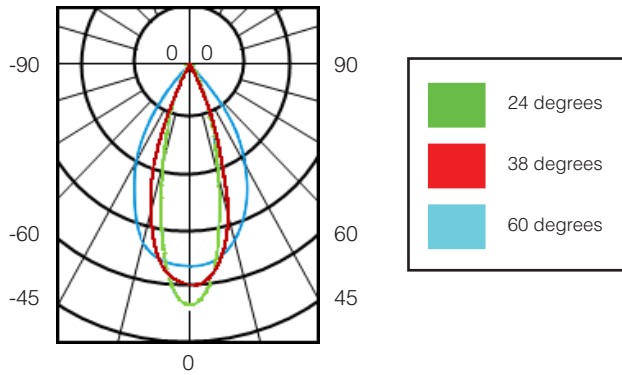

DIMENSIONS

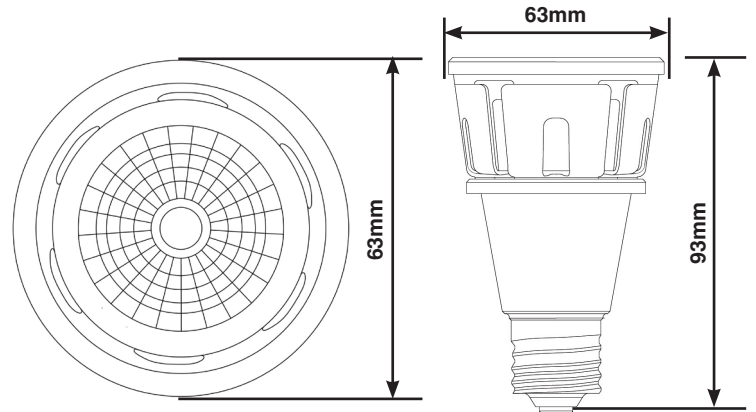

SPECTRAL POWER DISTRIBUTION

2700K

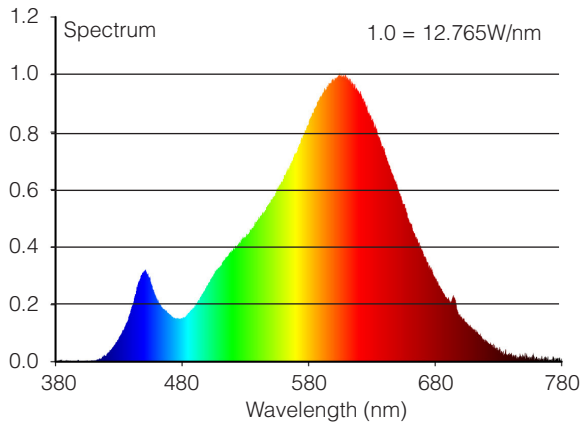

3000K

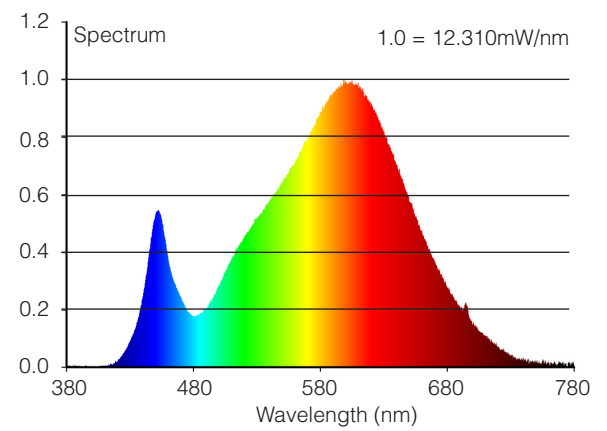

5000K

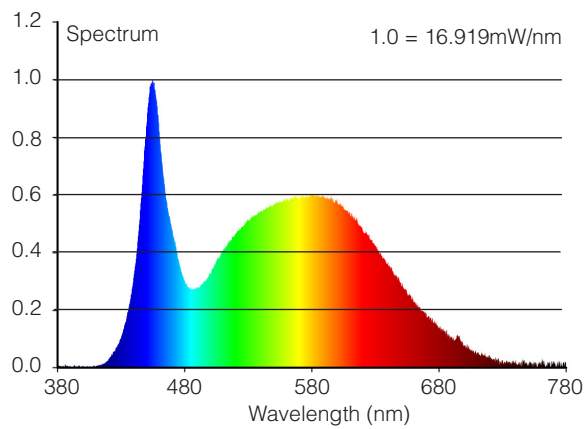

BEAM ANGLES

24 degrees

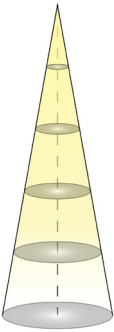

DISTANCE (m)	AVG./MAX. E (lux)			DIAMETER (m)
	2700K	3000K	4000K / 5000K	
1	1557 / 2169	1624 / 2262	1738 / 2421	0.43
2	389 / 542	406 / 565	435 / 605	0.85
3	173 / 241	180 / 251	193 / 269	1.28
4	97 / 136	102 / 141	109 / 151	1.71
5	62 / 87	65 / 91	70 / 97	2.13

38 degrees

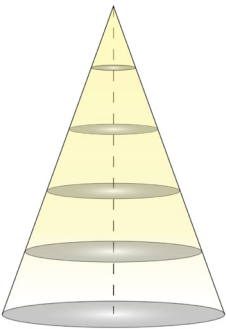

DISTANCE (m)	AVG./MAX. E (lux)			DIAMETER (m)
	2700K	3000K	4000K / 5000K	
1	786 / 1119	819 / 1167	877 / 1249	0.66
2	196 / 280	205 / 292	219 / 312	1.32
3	87 / 124	91 / 130	97 / 139	1.98
4	49 / 70	51 / 73	55 / 78	2.64
5	31 / 45	33 / 47	35 / 50	3.30

60 degrees

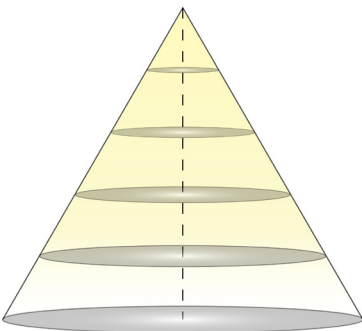

DISTANCE (m)	AVG./MAX. E (lux)			DIAMETER (m)
	2700K	3000K	4000K / 5000K	
1	353 / 572	368 / 596	394 / 639	1.03
2	88 / 143	91 / 149	99 / 160	2.06
3	39 / 64	41 / 66	44 / 71	3.09
4	22 / 36	23 / 37	25 / 40	4.12
5	14 / 23	15 / 24	16 / 26	5.15

WARRANTY

If the lamp fails to meet our specifications during the first 60 months, we'll replace it.

For additional warranty information, please refer to <http://www.leapfroglighting.com/resources/>.

APPLICATION NOTES

Not for use in exposed outdoor down-lighting applications

Ambient temperature within -20 to +40 °C

SAFETY NOTES

Warning: Risk of electric shock

Do not disassemble (no user serviceable parts)

Turn off power before inspection, installation or removal.

